

# SWEEP HANDLES AND GRIPS INSTRUCTION BOOKLET

## Contents

**Section I: Blue Sweep Grip Installation**

Refer to this section if you are installing blue cellular grips on your sweep oars.

**Section II: Green Sweep Grip Installation**

Refer to this section if you are installing green grips on your sweep oars.

**Section III: Microfiber Suede Patch Replacement**

Refer to this section if you are replacing worn microfiber suede patches on your sweep oars.

**Section IV: Retrofitting Microfiber Suede Grips**

Refer to this section if you are retrofitting microfiber suede grips on your sweep oars.

**Section V: Retrofitting Wood Veneer Grips on Sweep Oars**

Refer to this section if you are retrofitting wood veneer grips on your sweep oars.

**Section VI: Replacing 10 cm Length Adjustment System Sweep Handles with 5 cm Length Adjustment System Sweep Handles**

Refer to this section if your sweep oars currently have 10 cm length adjustment system sweep handles and you are replacing the handles with the 5 cm length adjustment system.

**Section VII: Replacing 10 cm Length Adjustment System Sweep Handles with Wood Sweep Handles**

Refer to this section if your sweep oars currently have 10 cm length adjustment system handles and you are replacing the handles with wood handles.

**Section VIII: Retrofitting the 10 cm Length Adjustment System Handles with the 5 cm Length Adjustment System Grips**

Refer to this section if your sweep oars currently have 10 cm length adjustment system handles and you are replacing the outside grips with the 5 cm length adjustment system grips.

**Section IX: Replacing Wood Sweep Handles with Wood or Composite Sweep Handles**

Refer to this section if your sweep oars currently have wood handles and you are replacing the handles with wood or composite handles.

**Section X: Required Maintenance of 10 cm Length Adjustment System**

Refer to this section for inspecting, cleaning, and proper maintenance.

**Section XI: Length Adjustment System Schematics**

Refer to this section for parts diagrams of both the 5 cm length adjustment system and the 10 cm length adjustment system.

**Important:** If you would like to remove a bonded composite handle from a sweep shaft, please call Concept2 for instructions at 800.245.5676.

Materials Needed	Procedure Overview
<ul style="list-style-type: none"> <li>• Blue sweep grips</li> <li>• Concept2 dual cartridge urethane glue kit and nozzle</li> <li>• Duo Pack cartridge gun or caulk gun and adapter</li> <li>• Utility knife</li> <li>• Paper towels</li> <li>• Source of convection heat (ie., toaster oven with tray or flat pan, convection oven; microwave will NOT work)</li> <li>• Aluminum foil</li> <li>• V-blocks for oars with bonded handles</li> <li>• Flathead screwdriver or T-20 (6-lobe) driver depending on grip fasteners</li> </ul>	<ul style="list-style-type: none"> <li>• Complete all preparations prior to mixing glue as it sets quickly.</li> <li>• Inject glue under grip.</li> <li>• Helper rotates handle while you pull grip into place. Glue acts as lubricant to ease grip installation.</li> <li>• Clean up. (First couple of installations will be messy.)</li> <li>• <b>Note:</b> If you are installing grips on an oar with the 5cm adjustable system (in which the outside grip is moveable and the composite handle is bonded) use these instructions for the inside grip replacement only. The outside grip is bonded to the movable core at our factory. Unscrew the clamp to replace the entire outside grip assembly.</li> </ul>

**INSIDE SWEEP GRIP**

**Preparation**

1. Support oars in V-blocks.
2. Review the transition graphic and note the three transition points on oar handle.
3. Pull or cut old grips off. Try not to cut composite handle under the grip.
4. Scrape loose glue off handle. See photo A.
5. Remove outside grip.
6. Heat blue grips at 120 F (49 C) for 10-12 minutes. Heat on tray or foil. Place foil on top to prevent scorching.

**Transition Graphic**

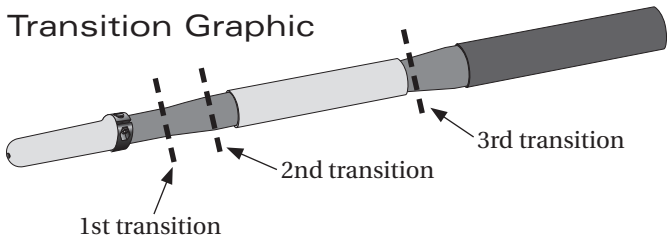

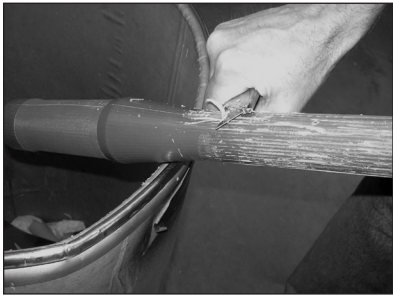

photo A

**Procedure**

1. Assemble glue gun following instructions.
2. If starting a new glue pack, squeeze handle of gun until mixed glue comes out the tip. **Note:** To prevent curing, dispense glue in nozzle every five minutes.
3. Pull heated grip onto handle to 1st transition. See illustration above.
4. Ensure tip of glue nozzle is clean by wiping with a paper towel.
5. Without injecting glue, insert tip of glue nozzle about 1" (2.5 cm) under end of grip at 45-degree angle. See photo B.

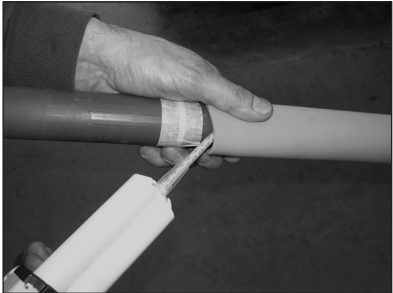

photo B

Procedure continued

6. Pull grip and nozzle together onto handle so tip of nozzle is 1/2" past 2nd transition. See photo C.
7. Begin injecting glue. Helper begins rotating handle in direction glue nozzle is pointed. See photos C and D.
8. When glue is about to seep from under grip, pull grip further onto handle while injecting more glue. Keep nozzle at 45 degree angle. Continue this process until grip is about 1" (2.5 cm) from final position.
9. Stop injecting glue. Stop rotating handle.
10. Remove glue nozzle from grip. Twist and pull grip to its final position (outside end of grip is 1/8" past 2nd transition).
11. Insert the glue nozzle one inch into the other (outside) end of the grip and inject a small amount of glue. Rotate the grip one full rotation.
12. Clean up excess glue.
13. After glue has set (15 minutes), ensure grip is tight. Inject more glue under loose areas if necessary.

photo C

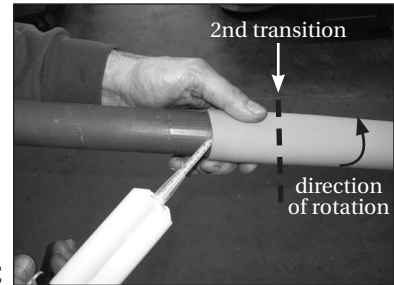

photo D

**Tips:**

- Try to inject more glue early in process and less as grip approaches final position.
- To keep handle clean, do not inject glue too early in process.
- If glue seeps out from under grip, inject less glue or pull grip on faster.

## OUTSIDE SWEEP GRIP - REMOVAL AND REPLACEMENT FOR 5 CM LENGTH ADJUSTMENT SYSTEM

## Procedure

**Note:** Note the setting on the length sticker before removing grip and Core.

1. Loosen the clamping screw on the old grip. (The clamping screw is located in the black band of the grip.)
2. Unscrew the old grip completely off the oar by turning the adjusting screw.
3. Screw the new grip onto the oar. Screw the new grip on until you reach the same overall length as you had with the old grip. **Note:** To ensure the adjusting screw engages the hole in the end plug, use a screwdriver to push in on the adjusting screw while pushing the grip onto the handle.
4. Tighten the clamping screw.

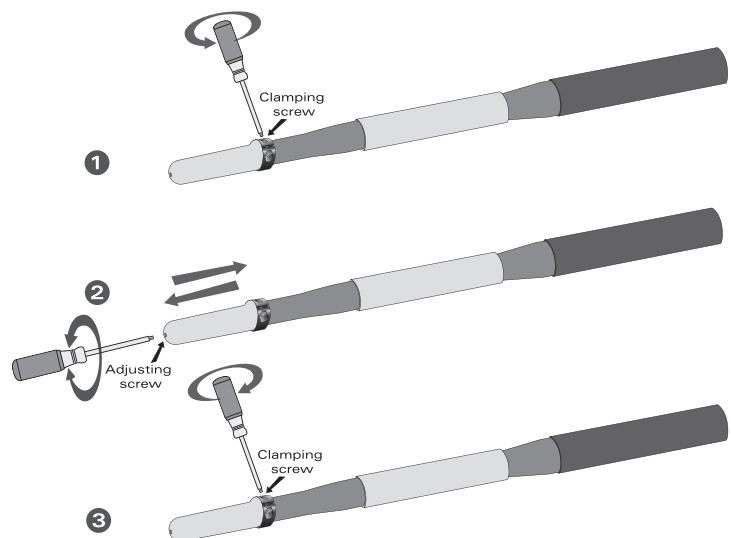

**OUTSIDE SWEEP GRIP - REMOVAL AND REPLACEMENT FOR  
10 CM LENGTH ADJUSTMENT SYSTEM****Procedure**

This applies only to the 10 cm adjustment system in which the composite handle is removable for length adjustment.

1. Pull or cut off old grips.
2. Warm new grips to 140 F (60 C).
3. Pull the warm grip all the way on to the handle.
4. Push the glue nozzle up under the grip as far as possible. Inject one handle squeeze of glue under the grip and withdraw the nozzle.
5. Rotate grip at least one full turn to spread the glue.
6. Clean up excess glue.

Materials Needed	Procedure Overview
<ul style="list-style-type: none"> <li>• Green sweep grips</li> <li>• Concept2 dual cartridge urethane glue kit and nozzle</li> <li>• Duo Pack cartridge gun or caulk gun and adapter</li> <li>• Utility knife</li> <li>• Paper towels</li> <li>• Source of convection heat (ie., toaster oven with tray or flat pan, convection oven; microwave will NOT work)</li> <li>• Leather glove or hot mitt</li> <li>• Aluminum foil</li> <li>• Sandpaper</li> <li>• V-blocks for oars with bonded handles</li> <li>• Flathead screwdriver or T-20 (6-lobe) driver depending on grip fasteners</li> </ul>	<ul style="list-style-type: none"> <li>• Complete all preparations prior to mixing glue as it sets quickly.</li> <li>• Inject glue under grip.</li> <li>• Helper rotates handle while you pull grip into place. Glue acts as lubricant to ease grip installation.</li> <li>• Clean up. (First couple of installations will be messy).</li> <li>• <b>Note:</b> If you are installing grips on an oar with the 5cm adjustable system (in which the outside grip is moveable and the composite handle is bonded) use these instructions for the inside grip replacement only. The outside grip is bonded to the movable core at our factory. Unscrew the clamp to replace the entire outside grip assembly.</li> </ul>

## INSIDE SWEEP GRIP

### Preparation

1. Support oars in V-blocks.
2. Review the transition graphic and note the three transition points on oar handle.
3. Pull or cut old grips off. Try not to cut composite handle under the grip.
4. Scrape loose glue off handle. See photo A.
5. Remove outside grip.
6. Heat green grips at 180 F (82 C) for 15 minutes. Heat on tray or foil. Place foil on top to prevent scorching.  
**Note:** The hotter the grips, the easier it will be to inject glue; however, if the grips are too hot, they will distort or melt.

### Transition Graphic

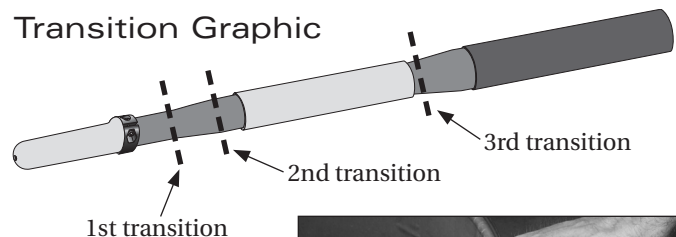

photo A



### Procedure

1. Assemble glue gun following gun instructions.
2. If starting a new glue pack, squeeze handle of gun until mixed glue comes out the tip. **Note:** To prevent curing, dispense glue in nozzle every five minutes.
3. Pull heated grip onto handle to 1st transition.
4. Ensure tip of glue nozzle is clean by wiping with a paper towel.
5. Without injecting glue, insert tip of glue nozzle about 1" (2.5 cm) under end of grip at 45-degree angle. See photo B.

photo B



Procedure continued

6. Pull grip and nozzle together onto handle so tip of nozzle is 1/2" past 2nd transition. See photo C.
7. Begin injecting glue. Helper begins rotating handle in direction glue nozzle is pointed. See photos C and D.
8. When glue is about to seep from under grip, pull grip further onto handle while injecting more glue. Keep nozzle at 45 degree angle. Continue this process until grip is about 1" (2.5 cm) from final position.
9. Stop injecting glue. Stop rotating handle.
10. Remove glue nozzle from grip. Twist and pull grip to its final position (outside end of grip is 1/8" past 2nd transition).
11. Clean up excess glue.
12. After glue has set (15 minutes), ensure grip is tight. Inject more glue under loose areas if necessary.

photo C

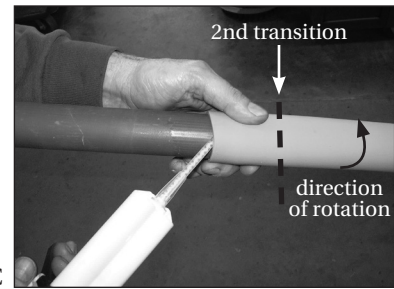

photo D

**Tips:**

- Try to inject more glue early in process and less as grip approaches final position.
- To keep handle clean, do not inject glue too early in process.
- If glue seeps out from under grip, inject less glue or pull grip on faster.

## OUTSIDE SWEEP GRIP - REMOVAL AND REPLACEMENT FOR 5 CM LENGTH ADJUSTMENT SYSTEM

## Procedure

**Note:** Note the setting on the length sticker before removing grip and Core.

1. Loosen the clamping screw on the old grip. (The clamping screw is located in the black band of the grip.)
2. Unscrew the old grip completely off the oar by turning the adjusting screw.
3. Screw the new grip onto the oar. Screw the new grip on until you reach the same overall length as you had with the old grip. **Note:** To ensure the adjusting screw engages the hole in the end plug, use a screwdriver to push in on the adjusting screw while pushing the grip onto the handle.
4. Tighten the clamping screw.

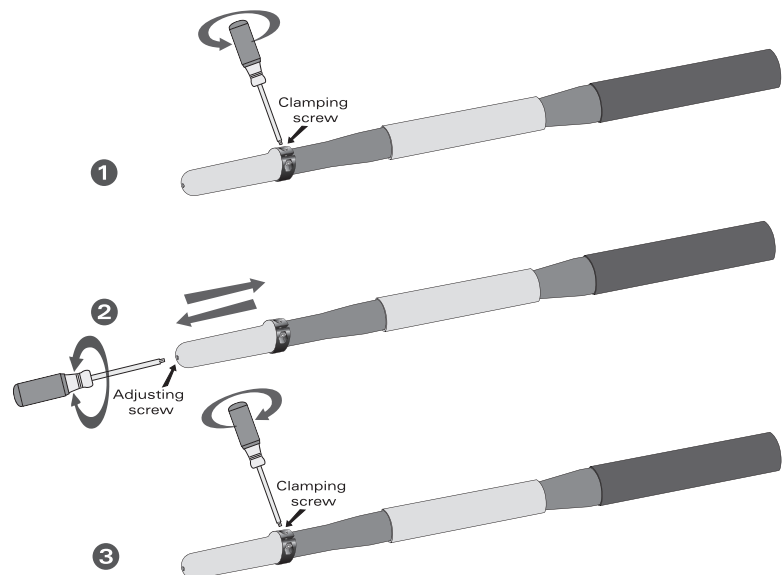

**OUTSIDE SWEEP GRIP - REMOVAL AND REPLACEMENT FOR  
10 CM LENGTH ADJUSTMENT SYSTEM****Procedure**

This applies only to the 10cm adjustment system in which the composite handle is removable for length adjustment.

1. Pull or cut off old grips.
2. Apply two thin beads of glue all the way around the inside of the grip; one half way in, the other near the open end.
3. Twist the grip onto the handle. The uncured glue acts as a lubricant. The more you twist, the easier it will be to push the grip all the way on.
4. Rotate grip at least one full turn to spread the glue.
4. Clean up excess glue.



Materials Needed	Procedure Overview
<ul style="list-style-type: none"> <li>• Microfiber suede inside and outside grip patches</li> <li>• Shrink/plastic wrap (if available)</li> <li>• Heat gun (or hair dryer)</li> </ul>	<ul style="list-style-type: none"> <li>• Remove old grips and any glue residue</li> <li>• Install replacement suede grip patches</li> <li>• Set oar length as appropriate</li> </ul>

**Note:** Microfiber suede grips are designed as a wearing item that will require regular inspection and maintenance. The main advantage of microfiber suede grips is that changing the patches is very easy, and provides a grip that performs well in a wide range of conditions. In our experience the average lifespan of suede patches during regular use is approximately one year, but is dependent on many factors such as heat, humidity, and cleanliness. Athletic tape applied to fingers is very abrasive to the suede material and will decrease the life of grip.

## INSIDE SWEEP GRIP

### Preparation

1. Support oars in V-blocks.
2. Heat the entire suede patch area with a heat gun or hair dryer. The glue will release from the handle more readily when warm.
3. Slowly peel the suede patch from the handle. Remove any remaining glue, which can usually be rubbed off with your fingers. For stubborn areas, dab the glue side of the removed patch on and off the residue that you wish to remove.

**Note:** Do not use solvents, cleaners or sandpaper to remove suede grips or glue.

### Procedure

1. Align the peeled edge parallel with the handle, so that the seam is opposite the grip clamp (facing towards the rower during the drive). Firmly press down along the chamfered edge. See photo A.
2. Peel away the remaining backing paper and wrap the suede patch around the handle. The long chamfered edge should land directly onto the other, creating a smooth seam. See illustration A. Firmly squeeze all areas of the patch to ensure proper adhesion.

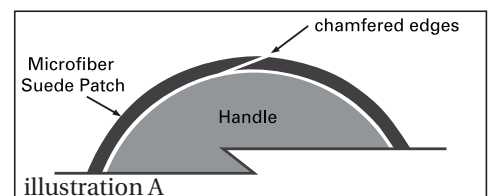
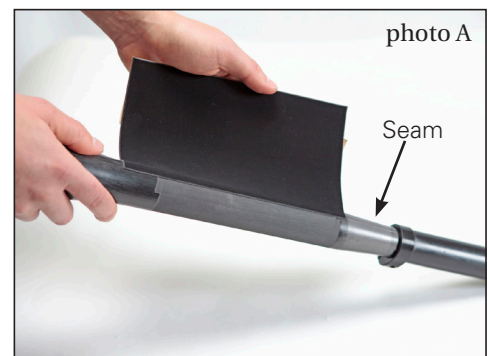



### Procedure continued

3. If possible, use shrink/saran wrap to tightly wrap the patch and leave it overnight. This helps to improve the bond between the new patch and handle. See photo B.



## OUTSIDE SWEEP GRIP

### Preparation

1. Support oars in V-blocks.
2. Heat the entire suede patch area with a heat gun or hair dryer. The glue will release from the handle more readily when warm.
3. Slowly peel the suede patch from the handle. Remove any remaining glue, which can usually be rubbed off with your fingers. For stubborn areas, dab the glue side of the removed patch on and off the residue that you wish to remove.

**Note:** Do not use solvents, cleaners or sandpaper to remove suede grips or glue.

### Procedure

1. Peel away the backing paper along one of the chamfered edges of the grip patch.
2. Align the peeled edge parallel with the handle, so that the seam is opposite the grip clamp (facing towards the rower during the drive). Also make sure the outside edge of the patch is flush against the outside edge of the grip core. Firmly press down along the chamfered edge. See photo C.
3. Peel away the remaining backing paper and wrap the patch around the plastic grip core. The chamfered edge should land directly onto the other, creating a smooth seam. See illustration A above. Firmly squeeze all areas of the patch to ensure proper adhesion.
4. If possible, use shrink/saran wrap to tightly wrap the patch and leave it overnight. This helps to improve the bond between the new patch and grip core. See photo B above.

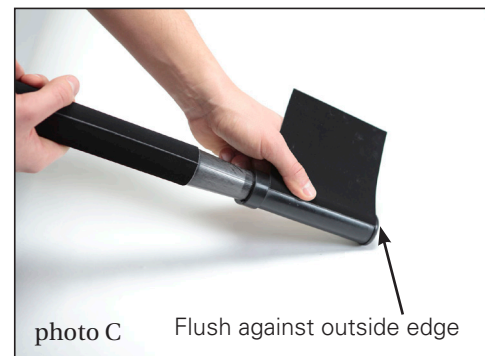

Materials Needed	Procedure Overview
<ul style="list-style-type: none"> <li>• Microfiber suede inside and outside grip patches</li> <li>• Shrink/plastic wrap (if available)</li> <li>• Utility knife</li> <li>• 120 grit or higher sandpaper</li> <li>• Flathead screwdriver or T-20 (6-lobe) driver depending on grip fasteners</li> </ul>	<ul style="list-style-type: none"> <li>• Remove old grips and any glue residue</li> <li>• Install replacement suede grip patches</li> <li>• Set oar length as appropriate</li> </ul> <p>• <b>Note:</b> Microfiber suede grips are designed as a wearing item that will require regular inspection and maintenance. The main advantage of microfiber suede grips is that changing the patches is very easy and inexpensive, and provides a grip that performs well in a wide range of conditions. In our experience the average lifespan of suede patches during regular use is approximately one year, but is dependent on many factors such as heat, humidity, and cleanliness. Athletic tape applied to fingers is very abrasive to the suede material and will decrease the life of grip.</p>

**INSIDE SWEEP GRIP**

**Preparation**

1. Support oars in V-blocks.
2. Review the transition graphic and note the three transition points on the oar handle. See illustration A.
3. Cut the old inside grip off with the utility knife, taking care not to cut the composite handle under the grip. Use the blade edge to remove as much glue as possible. See photo A. Gently sand the remaining glue off to create a smooth and clean surface.
4. Ensure the grip surface is smooth and free of glue and debris.

Transition Graphic

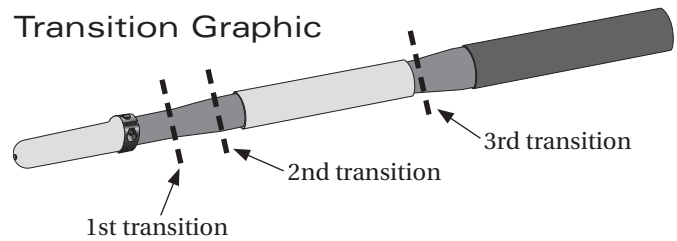

illustration A



photo A

**Procedure**

Follow SUEDE GRIP INSTALLATION SWEEP INSIDE GRIP procedure on page 8.

## OUTSIDE SWEEP GRIP

## Preparation

1. Support oars in V-blocks.
2. First note the setting on the length sticker before removing the grip, then remove the old grip by loosening the clamping screw and unscrewing the adjusting screw until it can be pulled off the handle. See illustration A.
3. Ensure the handle surface is clean and free of debris.

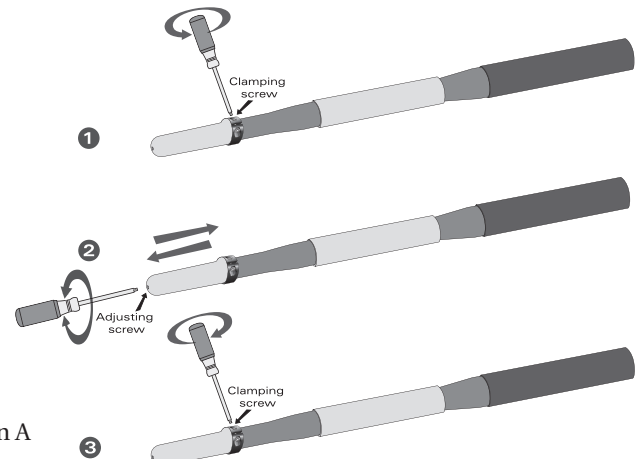

illustration A

## Procedure

1. Screw the new grip onto the oar until you reach the same overall length as you had with the old grip.  
**Note:** To ensure the adjusting screw engages the hole in the end plug, use the driver to push in on the adjusting screw while pushing the grip onto the handle. See illustration B.
2. Tighten the clamping screw.

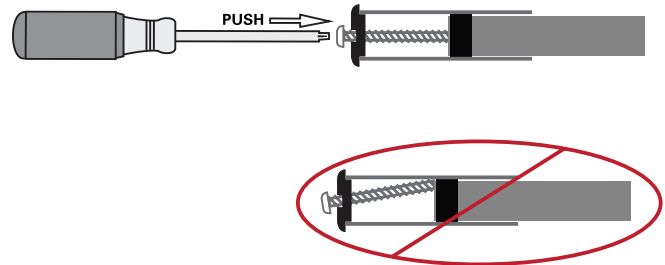
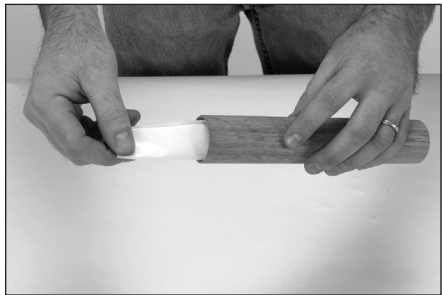
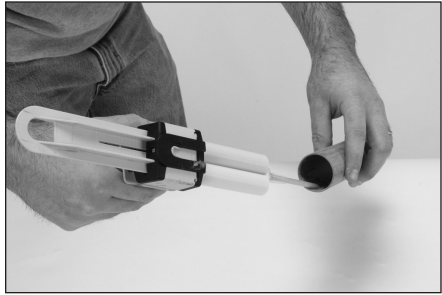



illustration B

Materials Needed	Procedure Overview
<ul style="list-style-type: none"> <li>• Paper towel or rag</li> <li>• Two-part injectable urethane glue</li> <li>• Wood veneer grips</li> </ul>	<ul style="list-style-type: none"> <li>• Remove old grips</li> <li>• Apply glue to wood veneer grips and to handle</li> <li>• Position wood veneer grip on handle</li> <li>• Wipe off excess glue and allow to dry</li> </ul> <p>Note: Remove old grips and be sure handles are clean and dry. Retrofit one grip at a time.</p>

Preparation	
<p>1. Remove protective paper from inside tubular grip. See photo A.</p>	 <p>photo A</p>
<p>2. Apply a 3mm bead of urethane around both inside ends of the tube and smear with tip of glue applicator, coating inside ends. See photo B.</p>	 <p>photo B</p>
<p>3. Liberally apply a two-part urethane in an extended figure eight pattern on the handle. See photos C.</p>	 <p>photo C</p>
<p>4. Slide tubular grip onto oar handle, turning it as you move the grip toward the insertion point of the carbon handle. See photo D.</p>	 <p>photo D</p>

**Procedure** continued

5. Remove the excess urethane that will ooze from tube.  
See photo E.

photo E



6. Ensure wood veneer grip is situated 2 – 5mm from the transition taper approaching the narrowest part of the oar handle. See photo F.

photo F

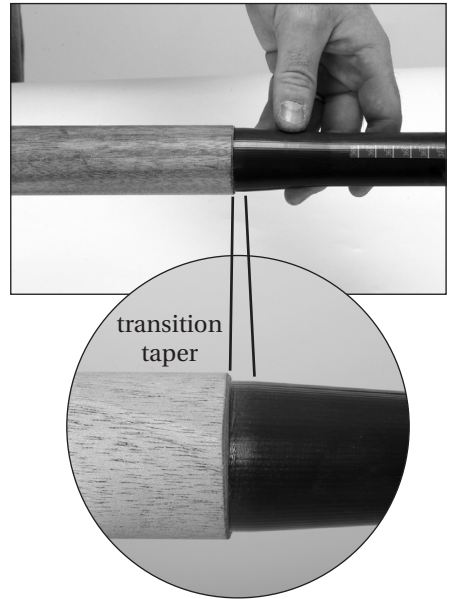

7. Allow the wood veneer grips to dry on carbon handles overnight before rowing with them. Photo G shows the finished oar handle ready for drying.

photo G



8. Attach outside grip, ensuring oar is set at desired length, and tighten the clamping screw. Repeat procedure with each grip and handle.

Materials Needed	Procedure Overview
<ul style="list-style-type: none"> <li>• 5cm handle</li> <li>• Tape measure</li> <li>• Sandpaper (80 or 120 grit)</li> <li>• Masking tape</li> <li>• Two-part injectable urethane glue from Concept2</li> <li>• Rags or paper towels</li> <li>• Drill and 4 mm (5/32”) drill bit</li> <li>• Hacksaw</li> </ul>	<ul style="list-style-type: none"> <li>• Ensure overall length of finished sweep will meet your needs, cutting shaft shorter if necessary</li> <li>• Bond handle of new adjustment system into shaft</li> <li>• Apply length sticker to handle</li> </ul>

Preparation																																									
<p>1. Currently, your sweeps have a 10 cm range of overall length adjustment. Your sweeps will have a 5 cm range of overall length adjustment with the new system. This preparation step will help you determine whether you need to cut the oar shaft to achieve the desired range of adjustment.</p> <ol style="list-style-type: none"> <li>a. Determine whether your existing handle is the long or short handle. Do this by removing your existing handle from the oar shaft (see step 3 for instructions on handle removal, if necessary) and measure it from tip to base. The long handle is 30.5 inches (77.5 cm); the short handle is 29.5 inches (75 cm).</li> <li>b. On the left side of the following chart, find your blade type, current handle length, and current 10 cm range of adjustment.</li> <li>c. Look across the same line to the corresponding numbers on the right. The numbers on the right represent your 5 cm range of adjustment post-conversion if you were to bond the 5 cm length adjustment system handles into your oar shaft at its current length.</li> </ol>																																									
<table border="1"> <thead> <tr> <th>Blade type</th> <th>Current handle length</th> </tr> </thead> <tbody> <tr><td>BB 52 cm</td><td>Short</td></tr> <tr><td>BB 52 cm</td><td>Long</td></tr> <tr><td>BB 52 cm</td><td>Long</td></tr> <tr><td>BB 55 cm</td><td>Short</td></tr> <tr><td>BB 55 cm</td><td>Short</td></tr> <tr><td>BB 55 cm</td><td>Long</td></tr> <tr><td>SMOOTHIE</td><td>Short</td></tr> <tr><td>SMOOTHIE</td><td>Short</td></tr> <tr><td>SMOOTHIE</td><td>Long</td></tr> </tbody> </table>	Blade type	Current handle length	BB 52 cm	Short	BB 52 cm	Long	BB 52 cm	Long	BB 55 cm	Short	BB 55 cm	Short	BB 55 cm	Long	SMOOTHIE	Short	SMOOTHIE	Short	SMOOTHIE	Long	<table border="1"> <thead> <tr> <th>10 cm range before conversion</th> <th>5 cm range after conversion</th> </tr> </thead> <tbody> <tr><td>366–376</td><td>369–374</td></tr> <tr><td>370–380</td><td>370.5–375.5</td></tr> <tr><td>374–384</td><td>374.5–379.5</td></tr> <tr><td>366–376</td><td>369–374</td></tr> <tr><td>370–380</td><td>373–378</td></tr> <tr><td>374–384</td><td>374.5–379.5</td></tr> <tr><td>366–376</td><td>369–374</td></tr> <tr><td>370–380</td><td>373–378</td></tr> <tr><td>374–384</td><td>374.5–379.5</td></tr> </tbody> </table>	10 cm range before conversion	5 cm range after conversion	366–376	369–374	370–380	370.5–375.5	374–384	374.5–379.5	366–376	369–374	370–380	373–378	374–384	374.5–379.5	366–376	369–374	370–380	373–378	374–384	374.5–379.5
Blade type	Current handle length																																								
BB 52 cm	Short																																								
BB 52 cm	Long																																								
BB 52 cm	Long																																								
BB 55 cm	Short																																								
BB 55 cm	Short																																								
BB 55 cm	Long																																								
SMOOTHIE	Short																																								
SMOOTHIE	Short																																								
SMOOTHIE	Long																																								
10 cm range before conversion	5 cm range after conversion																																								
366–376	369–374																																								
370–380	370.5–375.5																																								
374–384	374.5–379.5																																								
366–376	369–374																																								
370–380	373–378																																								
374–384	374.5–379.5																																								
366–376	369–374																																								
370–380	373–378																																								
374–384	374.5–379.5																																								
<p><b>Note:</b> If your current 10 cm range is not listed above, use the following formula to determine your new 5 cm range:</p> <p>Short handle: New 5 cm range if you currently have the short handle = (short end of current 10 cm range plus 3) to (long end of current 10 cm range minus 2). For example, if your current range is 368–378 cm and you have the short handle, your 5 cm range after conversion would be 371–376 cm.</p> <p>Long handle: New 5 cm range if you currently have the long handle = (short end of current 10 cm range plus .5) to the (long end of current 10 cm range minus 4.5). For example, if your current range is 375–385 cm and you have the long handle, your 5 cm range after conversion will be 375.5–380.5cm.</p>																																									

**Preparation — continued**

- d. If you need to make the 5 cm range shorter, cut the oar shaft. Every centimeter cut off the shaft alters the adjustment range down 1 cm. For example, if your current range is 370–380 with a SMOOTHIE blade and the short handle, and you remove 1 cm from the shaft, your new 5 cm range will be 372–377 vs. 373–378 noted in the chart on the previous page. Removing 2 cm will produce a 5 cm range of 371–376, and so on.
  - e. It is not possible to make the 5 cm range longer than what is noted in the chart.
  - f. To shorten the range, proceed to Step 2. If the range noted in the chart above is acceptable to you, then proceed to Step 1 of the Modification Procedure.
2. Mark the shaft:
    - a. At the handle end of shaft, measure the number of centimeters you want to remove. Mark shaft at this location.
    - b. Wrap masking tape around shaft, placing one edge of tape on mark. This will serve as your cutting guide, so apply the tape uniformly.
  3. Remove the old handles:
    - a. Loosen the adjustment screws two turns.
    - b. Tap screws down.
    - c. Pull handles and wedges out.
    - d. Completely remove adjustment screws.
    - e. Remove nut plate inside shaft.
    - f. Cover holes with masking tape.
  4. Cut shaft:
    - a. Using the tape applied in Step 2 as your guide, use a hacksaw to cut the shaft. See photo A.
    - b. Use sandpaper to smooth rough edges off cut edge.
  5. Proceed to Step 2 of the Modification Procedure.



photo A

**Modification Procedure**

1. If you have shortened your shaft, skip to Step 2. Otherwise, remove the old handles:
  - a. Loosen the adjustment screws two turns.
  - b. Tap screws down.
  - c. Pull handles and wedges out.
  - d. Completely remove adjustment screws.
  - e. Remove nut plate inside shaft.
  - f. Cover holes with masking tape.
2. Wipe inside of shaft and scuff first 5 inches of inside of shaft with sandpaper.
3. With 4mm (5/32") drill bit, drill two holes (bleed and inject) near end of shaft. See diagram.

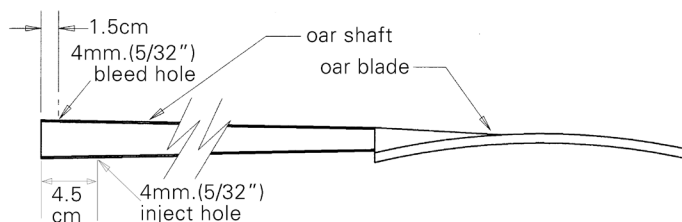



### Modification Procedure

4. Test fit new handles into end of shaft.
  - a. Inside end of handle should be snug in shaft when handle is 1/2" from final position.
  - b. If handle is loose, remove handle and wrap masking tape around end of handle as needed until fit is snug. See photo B.
5. Check handle and grip orientation:
  - a. Install new adjustable grip part way onto handle.
  - b. Orient handle in shaft so that clamp on adjustable grip is in same direction as blade face. See diagram at right.
6. Remove grip and push or tap handles in shaft until snug.
7. Begin gluing:
  - a. Assemble glue gun.
  - b. Insert glue nozzle to drilled hole farthest from handle.
  - c. Squeeze until glue emerges from other hole. (If you shortened your shaft, apply pressure on tape over old adjustment holes to prevent glue from coming out.)
  - d. Wipe up excess glue immediately.
  - e. Ensure clamp on grip is still properly oriented as described in Step 5. Adjust if needed.
  - f. Ensure handle is completely inserted in shaft. Adjust if needed.
8. Allow glue to set for 24 hours.
9. Install new adjustable grips:
  - a. Ensure clamping screw is loose.
  - b. Ensure double keyway on grip aligns with double keys on the handle.
  - c. Slide grip on.
  - d. Using screw- or powerdriver, push on screw head to engage end plughole and turn adjusting screw clockwise until overall length of sweep is at the maximum length of your new 5 cm adjustment range.
  - e. Trim ends of length sticker so that it includes min and max lengths of new 5cm range.
  - f. Align sticker with double keyway of grip.
  - g. Apply sticker with current length of sweep at edge of adjustable grip. See photo C.
  - h. Turn adjusting screw in grip until you achieve desired overall length.
  - i. Tighten clamping screw.

photo B

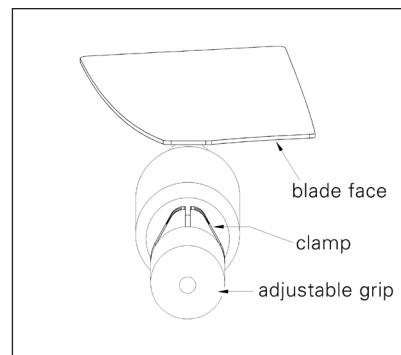
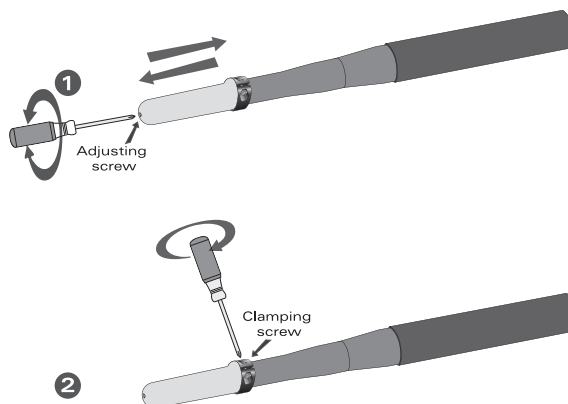

photo C



# SECTION VII: REPLACING 10 CM LENGTH ADJUSTMENT SYSTEM SWEEP HANDLES WITH WOOD SWEEP HANDLES

Materials Needed	Procedure Overview
<ul style="list-style-type: none"> <li>• Phillips screwdriver</li> <li>• Tape measure</li> <li>• Hammer</li> <li>• Wood saw</li> <li>• Medium grit sandpaper</li> <li>• Masking tape</li> <li>• Two-part injectable urethane glue from Concept2</li> <li>• Replacement handle from Concept2</li> <li>• Drill and 4mm (5/32") drill bit</li> </ul>	<ul style="list-style-type: none"> <li>• Ensure the new wood handle is long enough to achieve desired length</li> <li>• Remove adjustable handle</li> <li>• Prepare shaft for bonding</li> <li>• Bond wood handle to shaft</li> <li>• Cut handle to desired length</li> </ul>

## Procedure

1. Check that the new wood handle will be long enough to achieve the desired overall length. Standard wood handles will add 21" to the length of an oar. If a longer handle is required, it may be ordered from Concept2.
2. Remove the adjustable handle from the oar by loosening the two phillips head screws two turns and tapping them in. Remove the wedges, screws, and nut plate from inside the oar.
3. Sand the first 4"-5" inside the shaft to prepare it for bonding. Drill the two 4mm holes in the shaft using measurements as shown in the drawing.

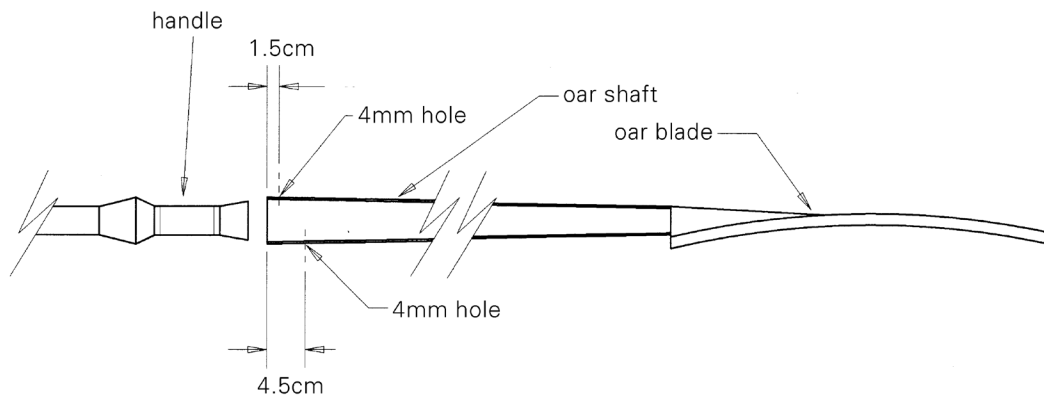

4. Check the fit of the handle in the shaft. The leading end of the handle should start to snug up about 1/2"-1" from the final position. Use sandpaper or masking tape to achieve this fit, then tap the handle the rest of the way in with a hammer. Check that the two holes in the shaft are clear.

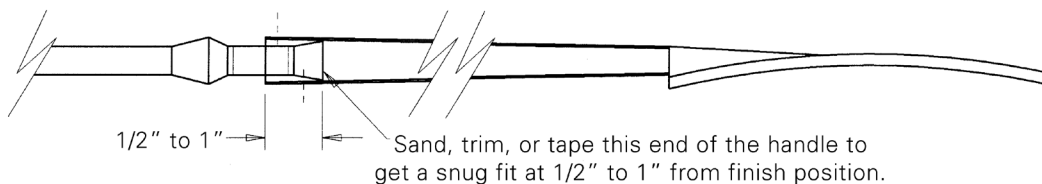

5. The handle is now ready to be glued. Follow the instructions for the two-part injectable urethane glue, then proceed with steps 6, 7, and 8.

**Procedure — continued**

6. Inject the glue into the larger of the two holes until the glue flows from the bleed hole. A wood sweep handle should take a little less than half of the 50 ml glue container. Note that the glue flows slowly and you should not try to inject too quickly.

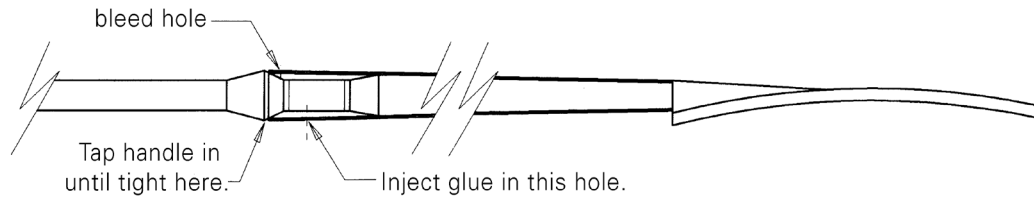

7. Use a small amount of the glue and some masking tape to fill the two adjustable handle screw holes.
8. After the glue has set up (one hour) proceed with correcting the final length of the oar by sawing the handle off at the desired length and smoothing the cut end with sandpaper.

**SECTION VIII: RETROFITTING THE 10 CM LENGTH ADJUSTMENT SYSTEM HANDLES WITH THE 5 CM LENGTH ADJUSTMENT SYSTEM GRIPS** PAGE 1 OF 2

Materials Needed	Procedure Overview
<ul style="list-style-type: none"> <li>• Phillips screwdriver</li> <li>• Drill with Phillips bit (optional)</li> <li>• Tape measure</li> <li>• Pencil or marker</li> <li>• Hacksaw (if needed)</li> <li>• Masking tape</li> <li>• Utility knife or other sharp knife</li> <li>• GooGone or mineral spirits</li> <li>• Disposable gloves</li> <li>• Paper towels</li> <li>• Sandpaper</li> <li>• Steel wool or a Scotchbrite pad</li> <li>• Loctite 409 Instant Adhesive .7 oz. tube (bonds 8 end plugs)</li> <li>• Concept2 2-part Urethane Adhesive 4 oz. kit (bonds 8 sweep handles)</li> </ul>	<ul style="list-style-type: none"> <li>• Inspect your oars</li> <li>• Convert your old handles to accept the adjustable grip</li> <li>• Determine your new adjustment range</li> <li>• Bond the handle into the shaft</li> </ul>

**Procedure**

1. Inspect your oars
  - a. Take the handle out of the oar shaft.
  - b. Determine if you have the “long” handle which measures 30.5” (77.5 cm), or “short” handle which measures 29.5” (75 cm). The handle length used was the result of the length and blade type originally ordered. Note that with the “long” handle you will be able to use the full 5 cm of adjustment of the new grip. With the “short” handle you will have 4 cm of adjustment.
  - c. Remove the outside grip by cutting it lengthwise with a sharp knife.
  - d. Remove the plug from the end of the handle.

**Note:** Before proceeding, test fit the new grip by sliding it onto the handle. If it is very tight you may have to sand the handle until the grip slides on easily. Remove any tape or glue from the handle, and clean any residue with GooGone or mineral spirits with steel wool or a scotchbrite pad.

2. Convert your old handles to the new outside grip
  - a. The new end plug for the adjustable grip must be glued in using the supplied Loctite 409. Be sure to orient the end plug as shown in the diagram.
 

**Note:** The orientation of the single key and double key of the end plug to the slot in the handle is identical for both port and starboard handles.
  - b. Apply a bead of Loctite 409 glue approximately 1/8” high and 1/4 inch wide to the inside end of the handle. Quickly insert the end plug in the correct orientation as illustrated in the diagram.
  - c. If you have a “short” handle, put a mark on the handle 4 3/4” (120mm) from the end of the new end plug. If you have a “long” handle, put a mark on the handle 5 1/8” (130mm) from the end of the new end plug. This will be the location of the new grip when it is in the shortest position.
  - d. Slide the new grip onto the handle, making sure the single key lines up with the single slot in the new grip and the double key lines up with the double slot.

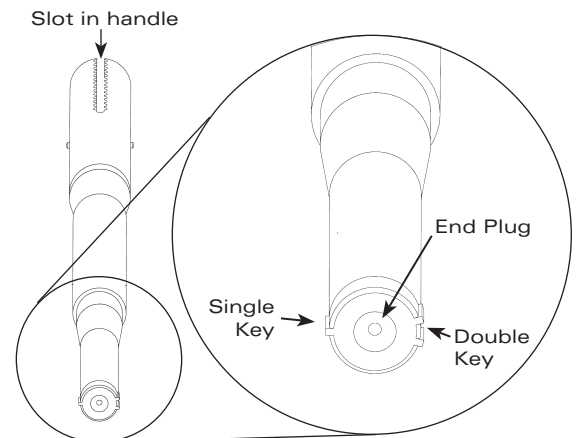

Procedure — continued

**Note:** To ensure the adjusting screw engages the hole in the end plug, use a screwdriver to push in on the adjusting screw while pushing the grip onto the handle.

- e. When you feel the adjusting screw engage in the center hole of the end plug, turn the screw clockwise to bring the grip further onto the shaft. (Applying pressure to the screwhead with a power driver is helpful here.)
- f. Adjust the grip to the shortest length position you have marked on the handle and leave it there for now.

3. Determine your 5 cm adjustment range

a. Decide what range of adjustment you want for the overall length of the oars you are retrofitting. The old handle had a 10 cm range of adjustment. A “long” handle will have 5 cm range. A “short” handle will have 4 cm range. For example, if the oars currently adjust from 370 cm to 380 cm, you might choose a new range of 373 cm to 378 cm.

b. Using the “old” 10 cm adjustment system, assemble the handle into the shaft in the position that gives you the shortest adjustment of the length range.

**Note:** If you cannot achieve a short enough minimum length, cut the difference off the oar shaft, not the handle. It will be easier to make a square cut if you wrap masking tape around the shaft with the edge of the tape at the cut line. Cut the shaft using a hacksaw.

c. With masking tape, mark the point on the handle where it enters the shaft. (The tape will be used as a guide when preparing parts for bonding and will make cleanup easier.)

d. Remove the handle from the shaft.

4. Bond the Handle into the Shaft

a. Clean and sand the surface of the handle that will be inside the oar shaft. Clean and sand both sides of the wedges used in the old handle adjusting system. If there are small, square plastic shims on the wedges, leave them in place.

**Note:** If you had to cut length off the shaft in Step 2 you will need to remove the two screws and nut plate that were used in the old adjustment system and tape over the screw holes when bonding the handle back into the shaft.

b. Put on the disposable gloves. Follow the adhesive instructions to mix the Concept2 two-part adhesive. Apply a thin layer of glue to the inside of the wedges and place them on the handle. Then apply a thin layer of glue to the outside of the wedges and a ring of glue to the inside edge of the shaft. Remember that the wedges are a tight fit so extra glue will be squeezed out. Insert the handle into the shaft. (If you cut the shaft and removed the screws and nut plate you must be sure the slot in the handle aligns with the screw holes.) Scrape off the excess glue, clean with paper towels and remove the masking tape.

c. Allow 24 hours for the adhesive to cure. To affix the length sticker it is easiest to set the grip at the longest setting of your new length range. Recheck the length with a tape measure. Place the sticker on the handle between the double slots on the inside of the grip as shown in the diagram. Press into place.

**Note:** If you have the “short” handle it is advisable to cut the length sticker to a 4 cm range before applying it to the handle.



# SECTION IX: REPLACING WOOD SWEEP HANDLES WITH WOOD OR COMPOSITE SWEEP HANDLES

PAGE 1 OF 2

Materials Needed	Procedure Overview
<ul style="list-style-type: none"> <li>• Wood saw</li> <li>• Drill with 1" bit</li> <li>• 4mm (5/32") bit</li> <li>• Hammer</li> <li>• Chisel</li> <li>• Knife</li> <li>• Coarse sandpaper</li> <li>• Two-part injectable urethane glue from Concept2</li> <li>• New handle from Concept2</li> </ul>	<ul style="list-style-type: none"> <li>• Cut off old handle at the shaft</li> <li>• Chisel out remaining wood from the shaft</li> <li>• Check and adjust fit of new handle</li> <li>• Inject glue</li> </ul>

## Procedure

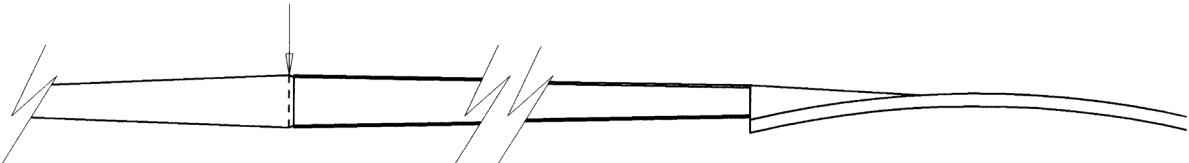
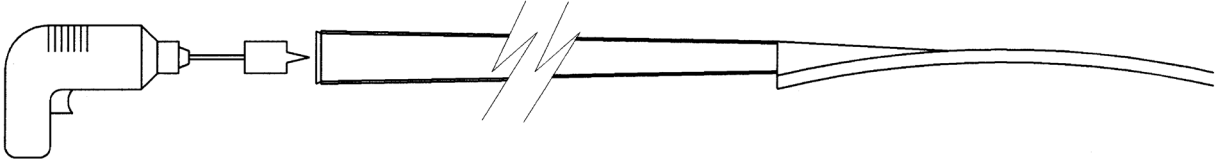
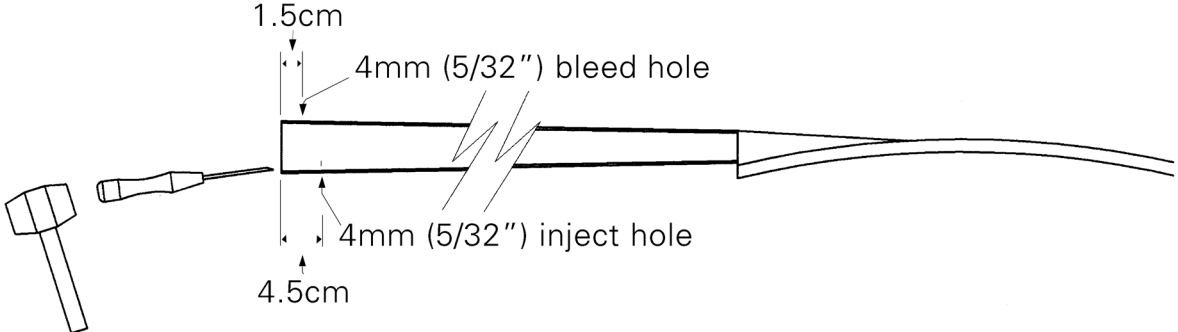
1. After measuring and noting the length of your oar, cut off the old handle at the end of the shaft.
 
2. Drill a large hole through the center of the remaining wood (3"-4" deep). Be careful not to damage the shaft.
 
3. Chisel all of the remaining wood and glue from the inside of the shaft, doing a final clean-up with a knife and sandpaper. Remove all loose material from inside the shaft.
 
4. Using the 4mm(5/32") bit, drill the glue injection and bleed holes as shown in the drawing.
 

**Note:** These holes may already be drilled but may need cleaning out.
5. Test and correct the fit of the new handle. Wooden handles should snug up about 1/2"- 1" from the final position. Use sandpaper or masking tape on the inside end of the handle to achieve this fit, then tap the handle the rest of the way in with a hammer. Composite handles should also snug up at about 1/2"-1" from the end and can be taped if they are too loose. If it is too tight, the inside end of the handle should be trimmed in 1/8" increments to achieve the correct fit. Tap the handle in with a hammer. Check the overall length of the oar before gluing.

Procedure - continued

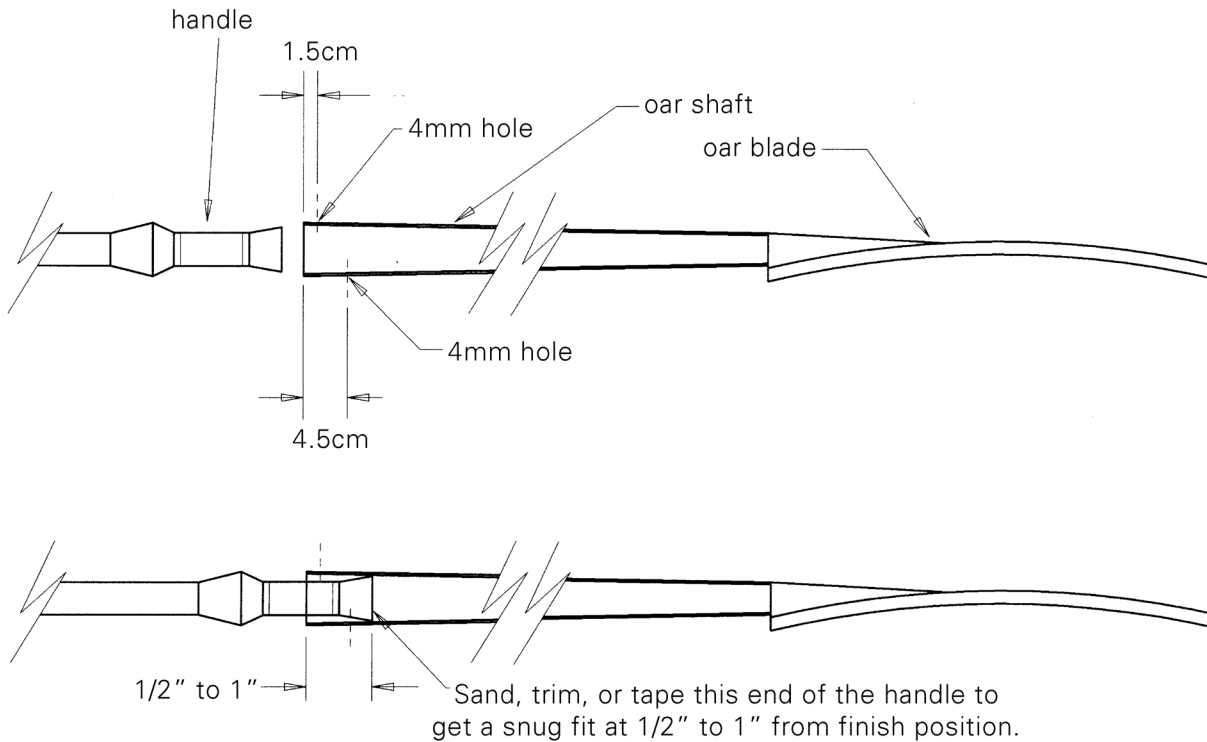

6. The handle is now ready to be glued. Follow the adhesive instructions for the two-part injectable urethane glue from Concept2.
7. Inject the glue into the inject hole as indicated until the glue flows from the bleed hole.  
**Note:** The glue flows slowly and you should not try to inject too quickly.

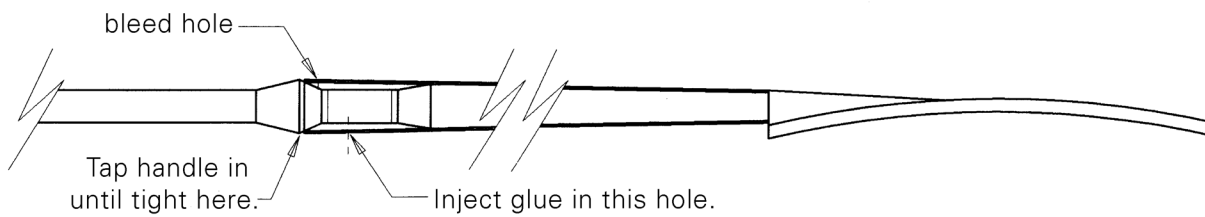

8. After the glue has set up (one hour), proceed with adjusting the final length of the handle and installing grips.



# SECTION X: REQUIRED MAINTENANCE OF 10 CM LENGTH ADJUSTMENT SYSTEM

**Note:** Proper maintenance of the 10 cm length adjustment system will greatly prolong the life of this system. You should remove the handle for maintenance at least once a season, more often if you row in salt water. Inspect and clean the handle parts each time you adjust the length of the oar.

Materials Needed	Procedure Overview
<ul style="list-style-type: none"> <li>• Phillips screwdriver</li> <li>• Paper towel or rag</li> <li>• Oil (machine or mineral oil, Concept2 chain oil)</li> <li>• Shims for wedges</li> <li>• Krazy Glue™ or Super Glue™</li> </ul>	<ul style="list-style-type: none"> <li>• Check for handles that are too loose or too tight, adjusting if necessary</li> <li>• Inspect and clean the handle and parts of the adjustment system</li> <li>• Replace any worn or broken parts</li> </ul>

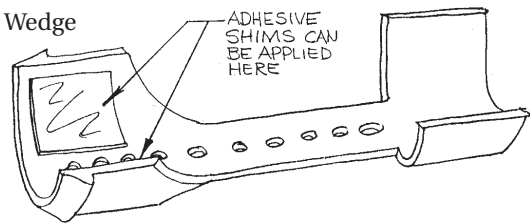
Procedure
<ol style="list-style-type: none"> <li>1. Loosen the handle screws with four complete turns and gently tap them down flush to disengage the internal nut plate from the handle slot.</li> <li>2. With the screws loosened, support the shaft and wiggle the handle to check for looseness in the shaft. If it is loose you will need to adjust the fit. Refer to # 9 below.</li> <li>3. Before removing the handle from the shaft, note the length setting for reassembly. If the handle does not come out, have someone else hold the shaft end of the oar on a stable surface while you ease the handle out. If the handle does not come out, call Concept2.</li> <li>4. Check the condition of the handle screws. If they did not function smoothly, remove completely and clean and oil them, or replace both the nut plate and screws. <b>Note:</b> If the screw heads are damaged but the threads function smoothly, replace one screw at a time, avoiding reassembly of the internal nut plate. Be sure to tighten one screw before removing and replacing the other screw.</li> <li>5. Inspect and clean the wedges (see drawing below) and the inside of the oar shaft. The wedges are fitted for snugness using thin plastic shims.</li> <li>6. Inspect the handle, especially the slot, for excessive wear. If you are working on a sweep oar, ensure the two black plastic nubs on the nut plate that engage the wedges are in good condition. A scull nut plate does not have the nubs. If the condition of the handles, parts, or the inside of the shaft is a concern, contact Concept2.</li> <li>7. Lightly oil the screw threads. Select your length and reassemble, making sure the handle goes back into the shaft from which it came.</li> <li>8. It should take about 10 lbs. of force to push a clean handle completely to the seated position. If it is too tight, there may be dirt on the handle, shaft or wedges. If a clean handle is too tight, you can adjust the fit by removing one or more of the plastic shims on the wedge.</li> <li>9. If the handle is too loose, you can add shims (available from Concept2) to the wedges in the location shown in the drawing below.</li> </ol> <div style="text-align: center;">  </div> <p>The shims are adhered to the wedges using Krazy Glue™ or Super Glue™. Concept2 recommends that you use four shims at most (two on each wedge). If the handle is still loose with four shims, contact Concept2 about possible fixes, which include bonding the handle to the shaft or retrofitting the 5 cm length adjustment system.</p> <ol style="list-style-type: none"> <li>10. Tighten the two handle screws.</li> </ol>

# SECTION X: LENGTH ADJUSTMENT SYSTEM SCHEMATICS

## 5 CM LENGTH ADJUSTMENT SYSTEM

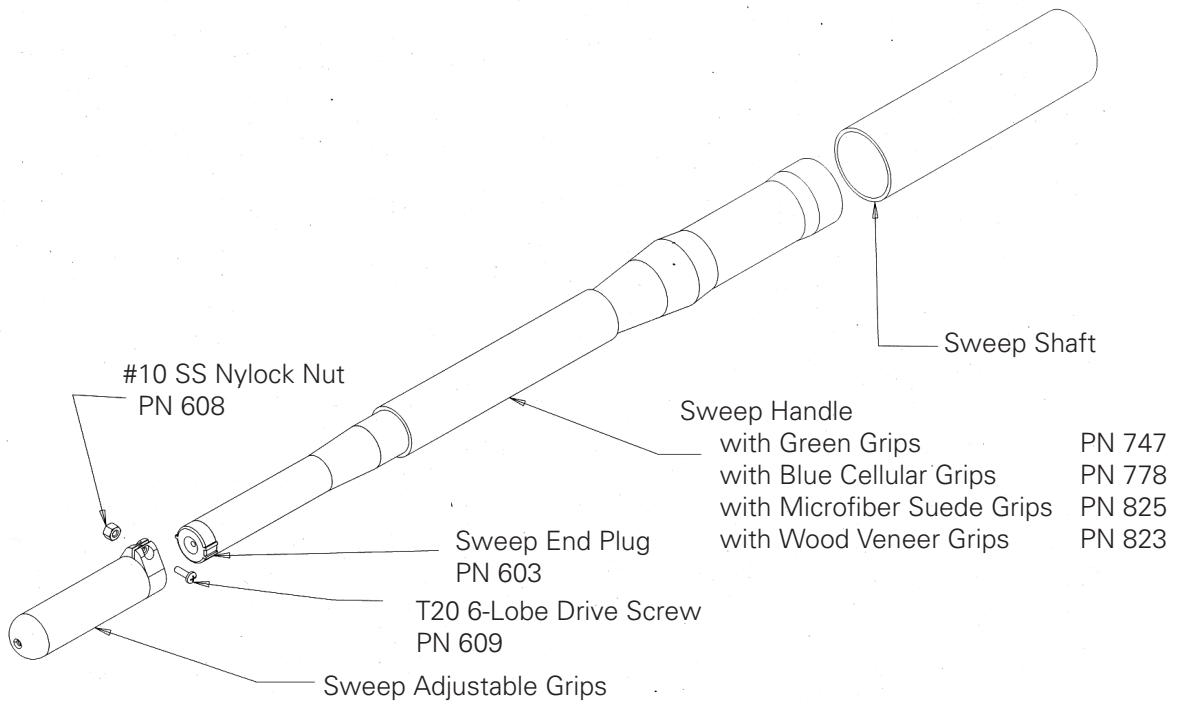

## 10 CM LENGTH ADJUSTMENT SYSTEM

